

















STERILIZZ. U.V.16W

	REF	ART	COD
	100	REAKTOR STERILIZER	IV5806016
	102	STARTER	IV5806015
	104	STARTERTÜR	IV5806010
	108	ROEHREHALTERER Füß	IV5846010
	110	UVIOL-ROEHRE STERILIZER 16W 	IV5846016
	114	TIMER FACE FOR STERILIZER	IV4206010
	116	SCHALTER STERILIZER 	IV5806001
	118	Drehknopf DEM TIMER	IV4206000
	119	TIMER FACE FOR STERILIZER	IV4206010
	120	2 STUNDEN TIMER 	IV5966000
	124	MICROSHALTER STERILIZER	IV5826000
	140	KABEL MIT STECKER 1-PH SCHUKO	19410502
	142	CABLE GLAND	IV5886000

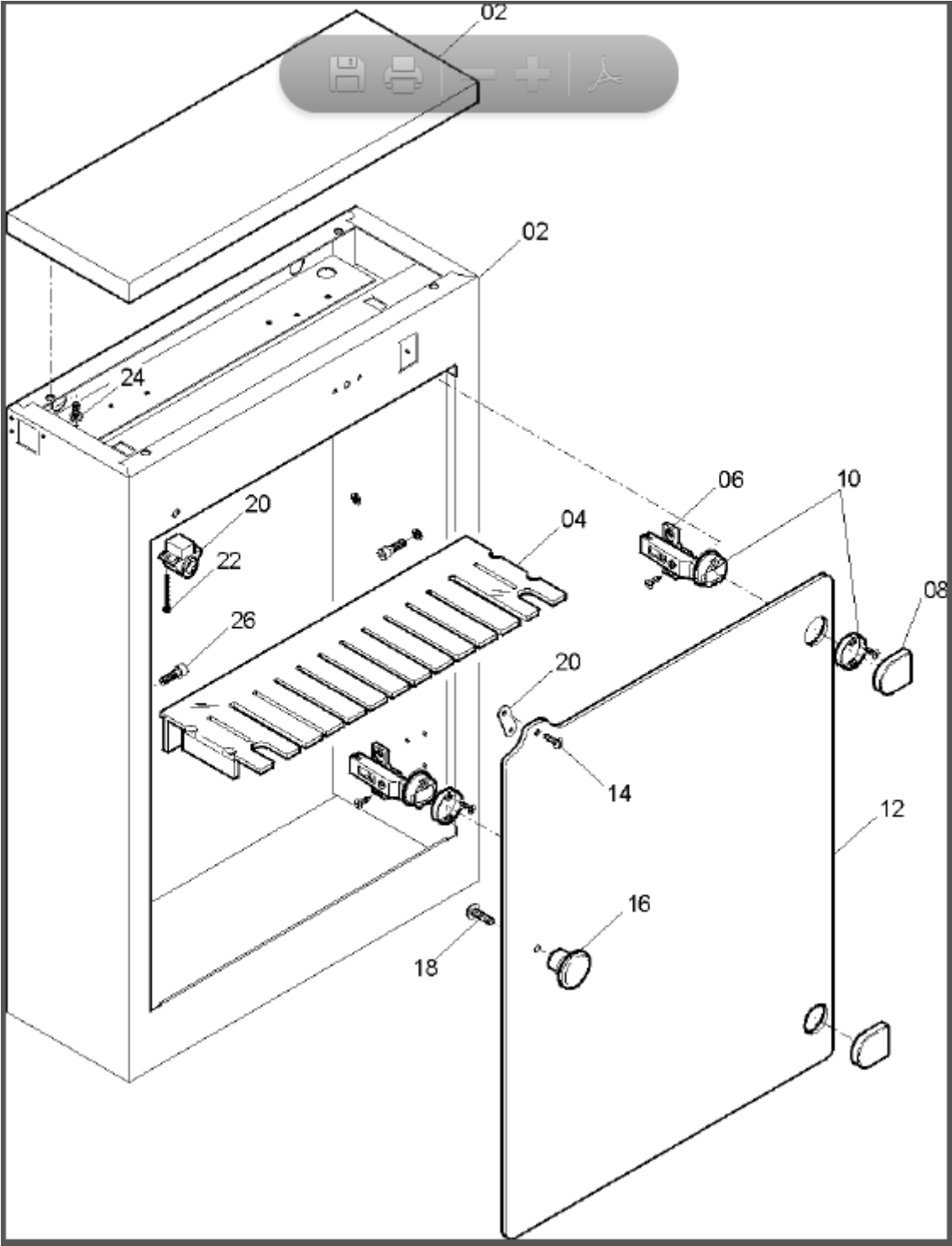

STERILIZZ. U.V.16W

	REF	ART	COD
	02	MOBILETTO COMPLETO 16 W	IV2486016
	04	PORTACOLTELLI PLEXI 16 W	GM4253150
	06	BASE FOR DOOR PIVOT	IV7506017
	08	PLASTIC PIECE FOR DOOR PIVOT	IV7506018
	10	DOOR PIVOT	IV7506000
	12	BROWN PLEXI SHUTTER UVA 16W	IV4236010
	16	SHARPENER HOUSING KNOB	19562702
	20	MAGNET FOR STERILIZER	IV5826016